

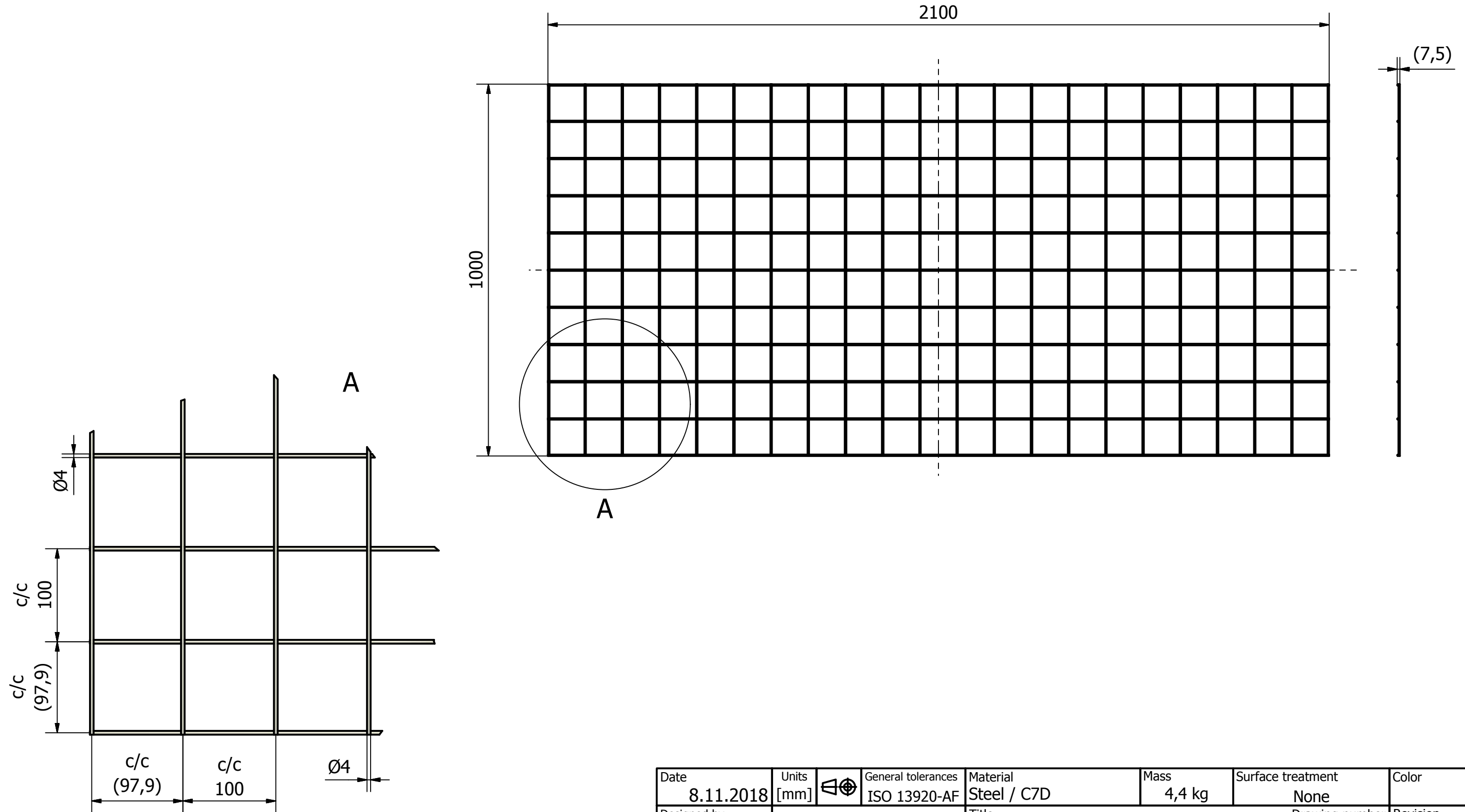

Parts List						
Item	Part Number	Quantity	Code	Description	Material	Mass
1	F-panel_Botten	1		Ø4 x Ø 4 / 100 x 100 / 1000 x 2100	C7D	4,4 kg
2	F-panel_Baksida	1		Ø4 x Ø 4 / 100 x 100 / 1000 x 2100	C7D	4,4 kg
3	F-panel_Front	1		Ø6 x Ø 6 / 150 x 150 / 1050 x 2100	C7D	7,2 kg
4	F-panel X	3		F-panel X	C4D	1,9 kg
5	Märla	98			S355	0,0 kg

Date 8.11.2018	Units [mm]	General tolerances ISO 13920-AF	Material Steel /	Mass 22,0 kg	Surface treatment None	Color
Designed by M.Röman			Title F-panel	Drawing number F-panel		Revision
Checked & approved by Skg			Part F-panel	Part Number F-panel	Sheet 1 / 5	
Phone: +358 201 450 201						

Parts List						
Item	Part Number	Quantity	Code	Description	Material	Mass
1	F-panel_Botten	1		Ø4 x Ø 4 / 100 x 100 / 1000 x 2100	C7D	4,4 kg



Date	8.11.2018	Units	[mm]	General tolerances	ISO 13920-AF	Material	Steel / C7D	Mass	4,4 kg	Surface treatment	None	Color	
Designed by	M.Röman	 Phone: +358 201 450 201		Title	Ø4 x Ø 4 / 100 x 100 / 1000 x 2100		Drawing number	F-panel		Revision			
Checked & approved by	Skg			Part	Ø4 x Ø 4 / 100 x 100 / 1000 x 2100		Part Number	F-panel_Botten		Sheet	2 / 5		

Parts List						
Item	Part Number	Quantity	Code	Description	Material	Mass
1	F-panel_Baksida	1		Ø4 x Ø 4 / 100 x 100 / 1000 x 2100	C7D	4,4 kg

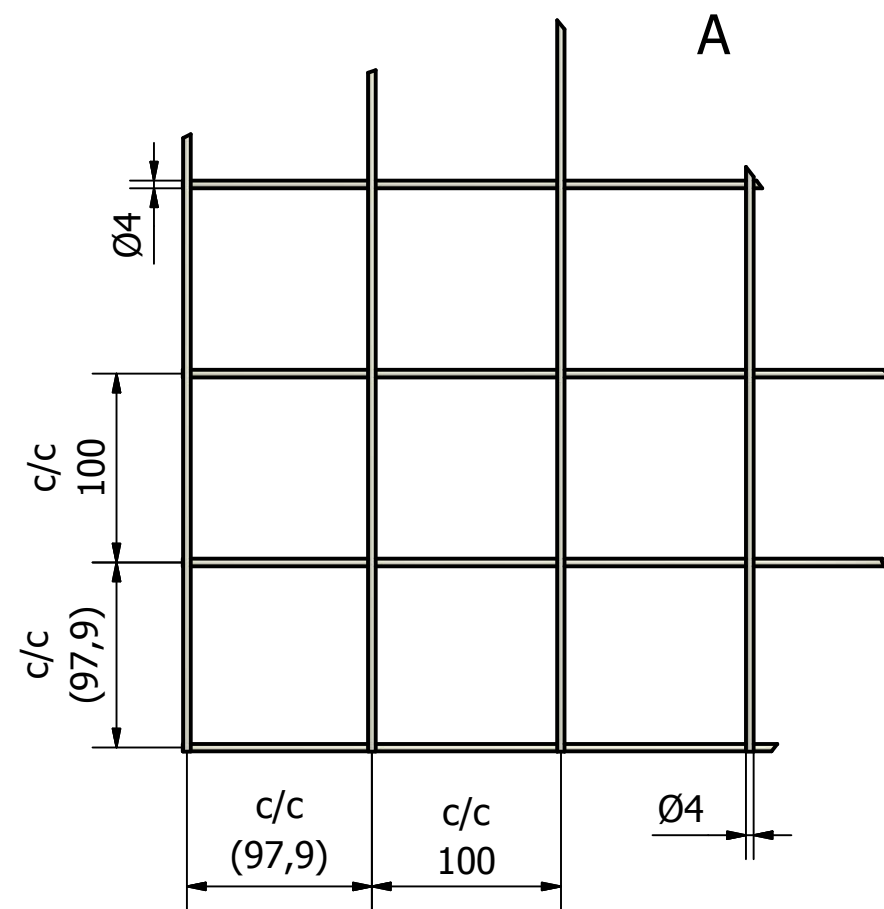
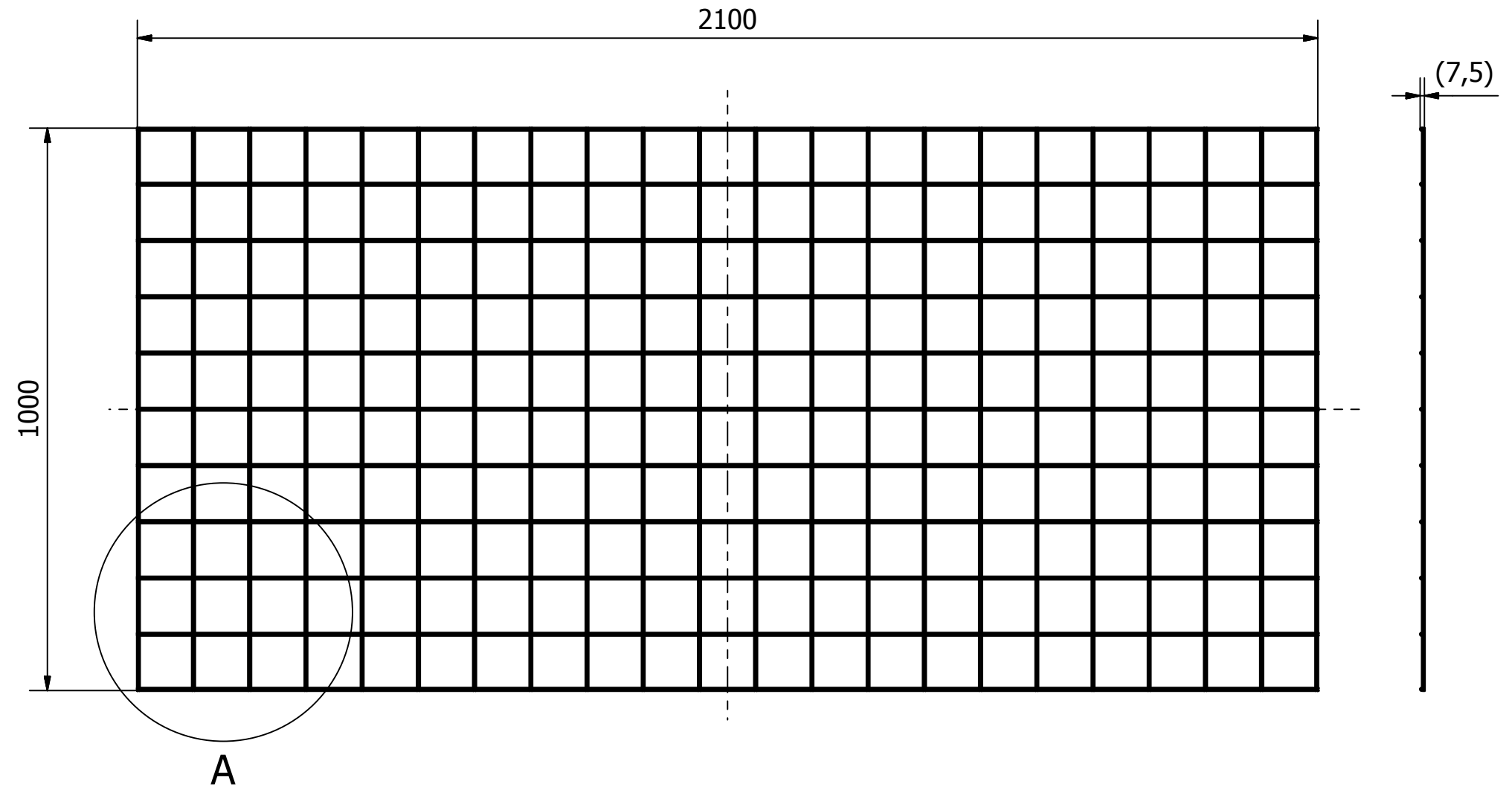

Date 8.11.2018	Units [mm]	General tolerances ISO 13920-AF	Material Steel / C7D	Mass 4,4 kg	Surface treatment None	Color
Designed by M.Röman			Title Ø4 x Ø 4 / 100 x 100 / 1000 x 2100	Drawing number F-panel	Revision	
Checked & approved by Skg			Part Ø4 x Ø 4 / 100 x 100 / 1000 x 2100	Part Number F-panel_Baksida	Sheet 3 / 5	

Parts List						
Item	Part Number	Quantity	Code	Description	Material	Mass
1	F-panel_Front	1		Ø6 x Ø 6 / 150 x 150 / 1050 x 2100	C7D	7,2 kg

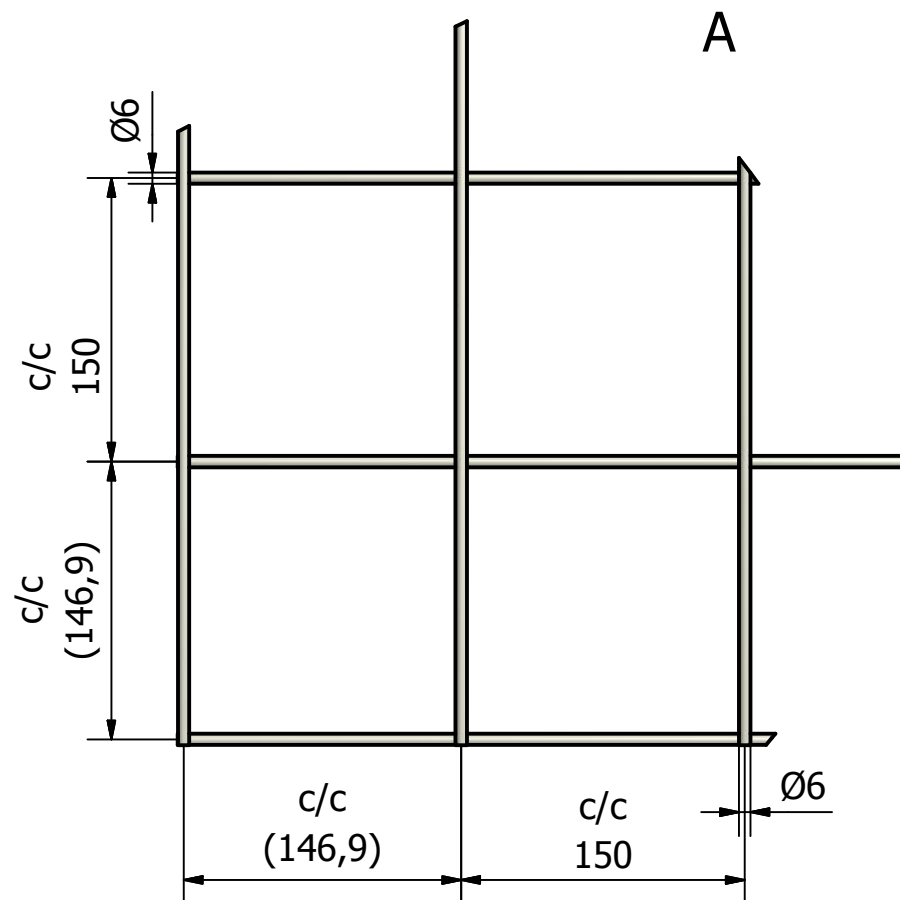
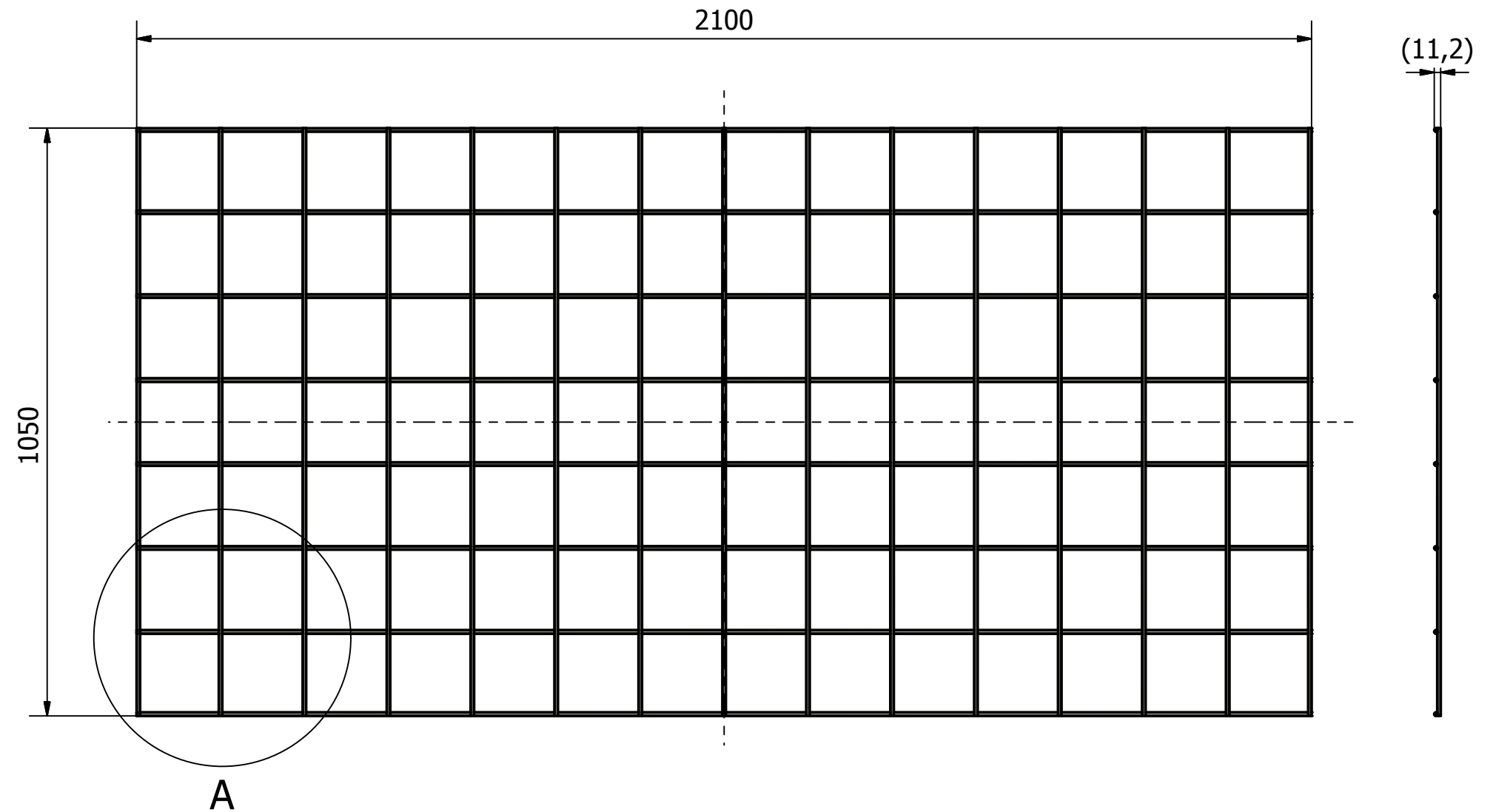

Date	8.11.2018	Units	[mm]	General tolerances	ISO 13920-AF	Material	Steel / C7D	Mass	7,2 kg	Surface treatment	None	Color	
Designed by	M.Röman	<b>TAMMET</b>		Title	Ø6 x Ø 6 / 150 x 150 / 1050 x 2100			Drawing number	F-panel		Revision		
Checked & approved by	Skg			Part	Ø6 x Ø 6 / 150 x 150 / 1050 x 2100			Part Number	F-panel_Front		Sheet	4 / 5	
				Phone:	+358 201 450 201								

Parts List						
Item	Part Number	Quantity	Code	Description	Material	Mass
1	F-panel X	1		F-panel X	C4D	1,9 kg

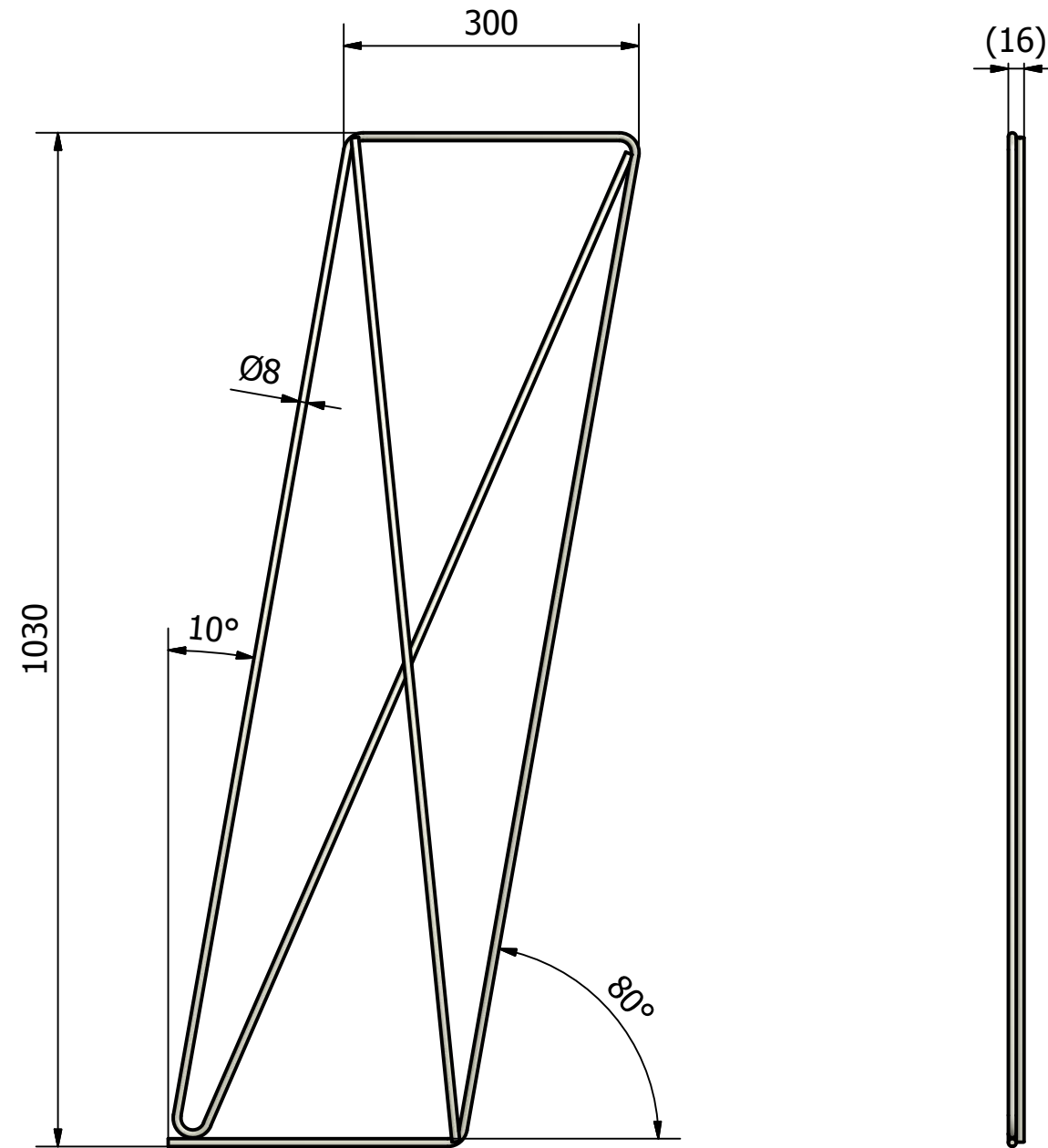
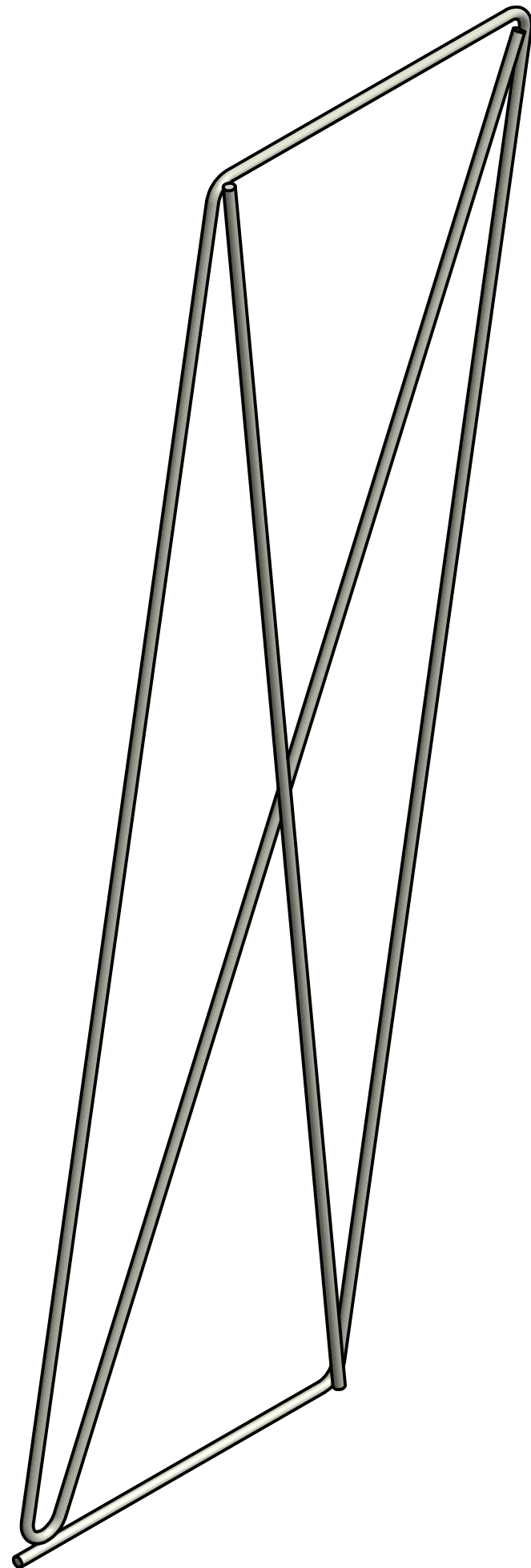

Date 8.11.2018	Units [mm]	General tolerances ISO 13920-AF	Material Steel / C4D	Mass 1,9 kg	Surface treatment None	Color
Designed by M.Röman	 Phone: +358 201 450 201		Title F-panel X	Drawing number F-panel	Revision	
Checked & approved by Skg			Part F-panel X	Part Number F-panel X	Sheet 5 / 5	